

1

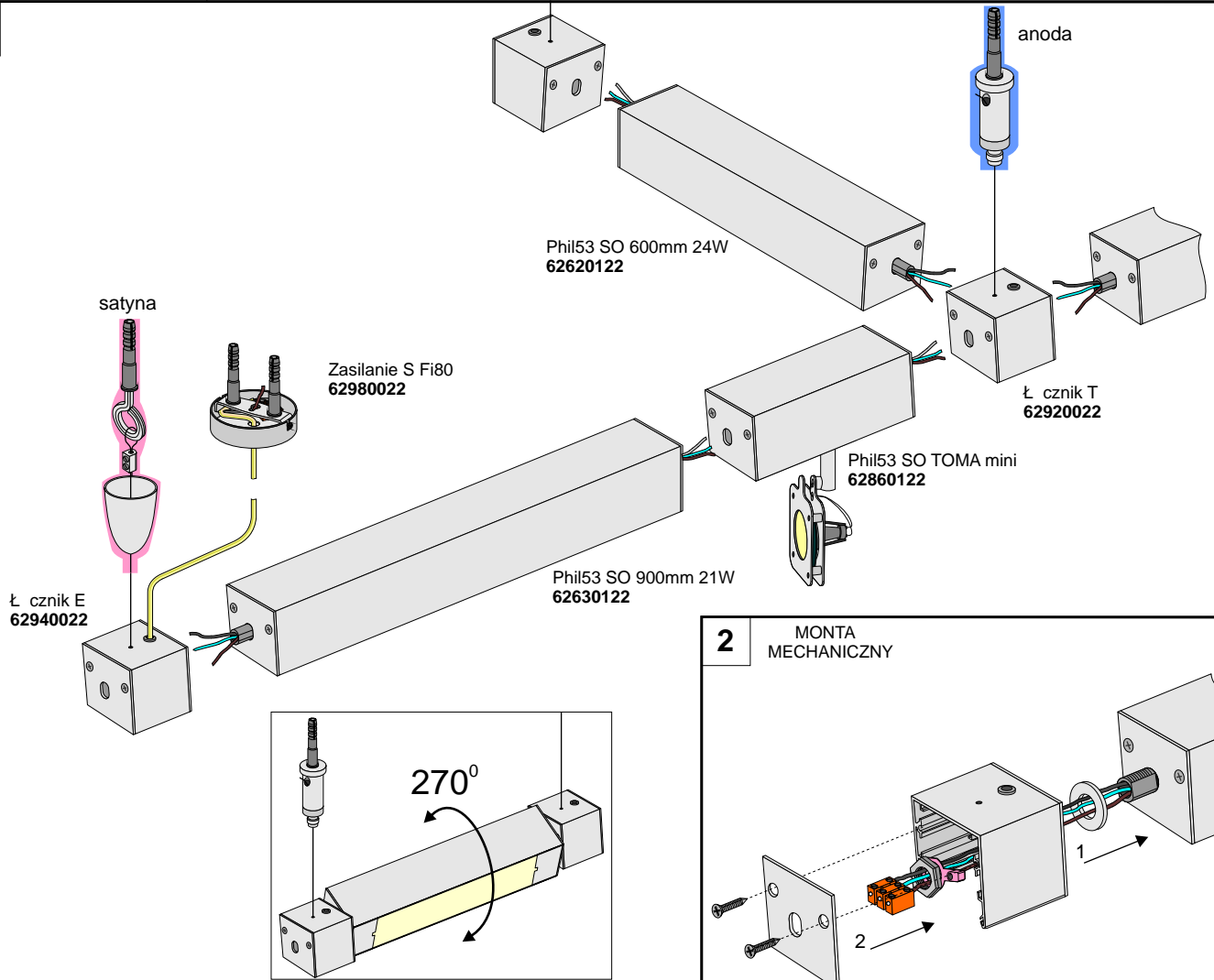

2 MONTA MECHANICZNY

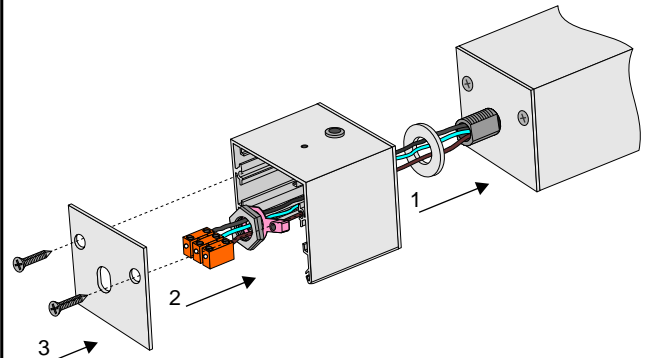

6 POŁ CZENIE ELEKTRYCZNE

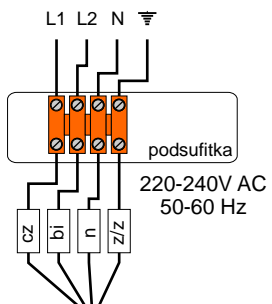

kolorystyka przewodów:
b - br z cz - czarny
bi - biały n - niebieski
bb - bezbarwny z/z - żółto-zielony

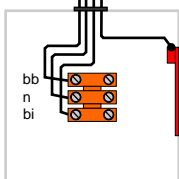

Ł cznik E
anoda: 62940020
srebro: 62940022

5 ZAWIESIE: MOCOWANIE LINKI

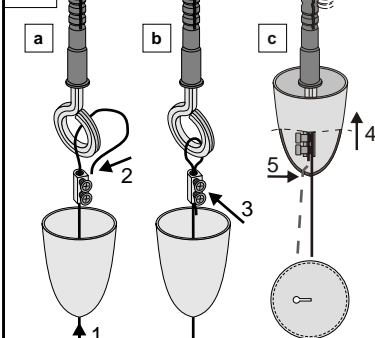

6 MOCOWANIE LINKI DO ZAWIESI

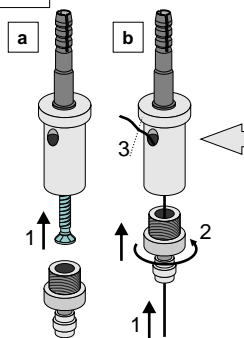

WYJMOWANIE LINKI Z ZAWIESI

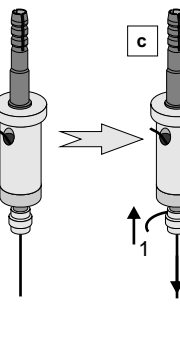

7 MONTA PODSUFITKI

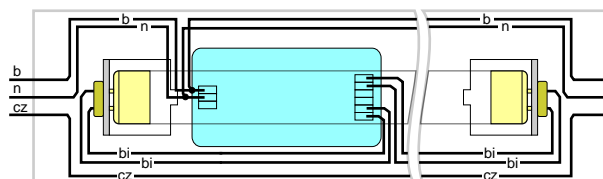
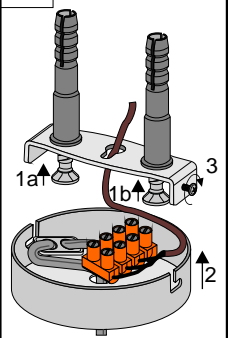

Phil53 SO
600 mm, 900 mm, 1200 mm, 1500 mm

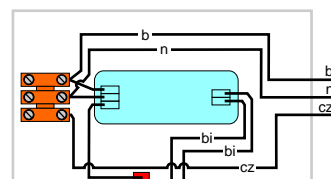

Reflektory
MAXI STAR TECHNO
RETAKA
TOMA, TOMA MINI

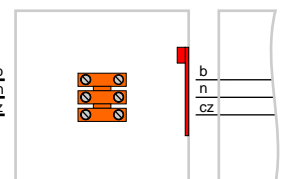

Ł cznik I
anoda: 62900020
srebro: 62900022

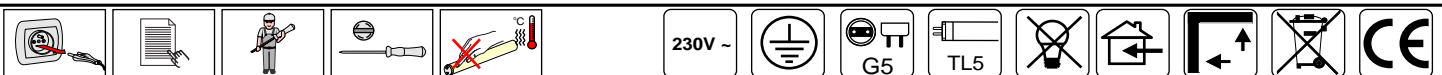

1 Phil53 SO

Phil53 SK

Phil53 BN

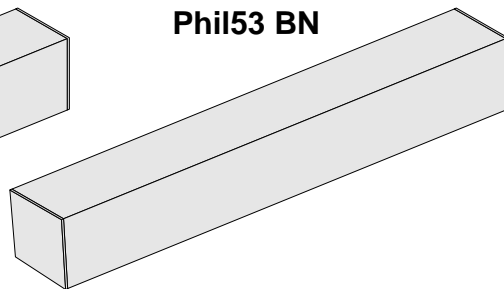
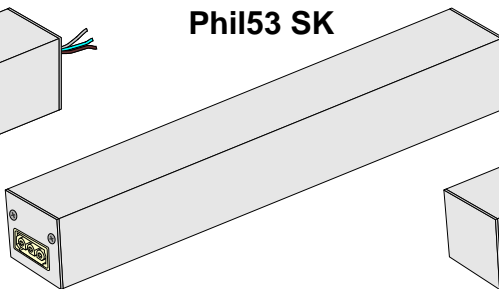
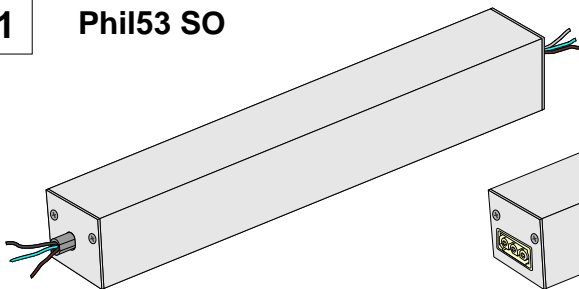

2 WYJMOWANIE WIETŁÓWKI

2a

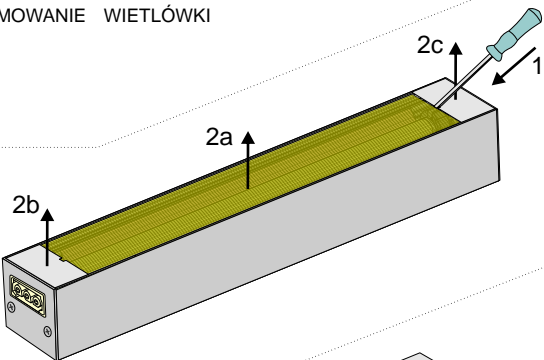

2b

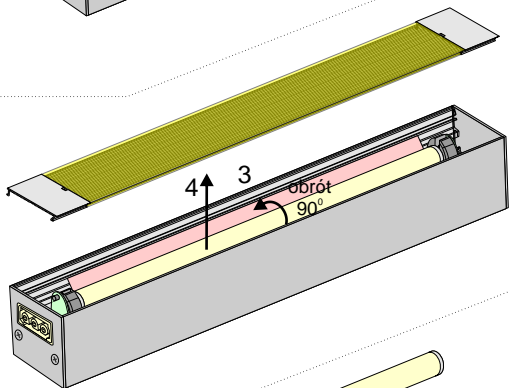

2c

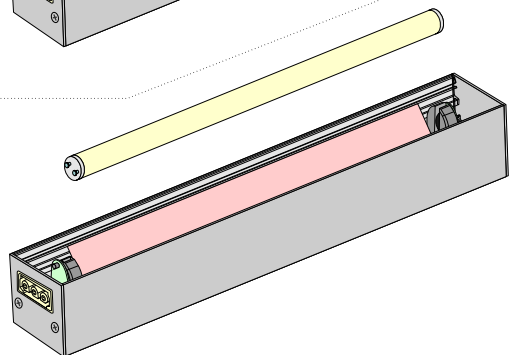

3 WKŁADANIE WIETŁÓWKI

3a

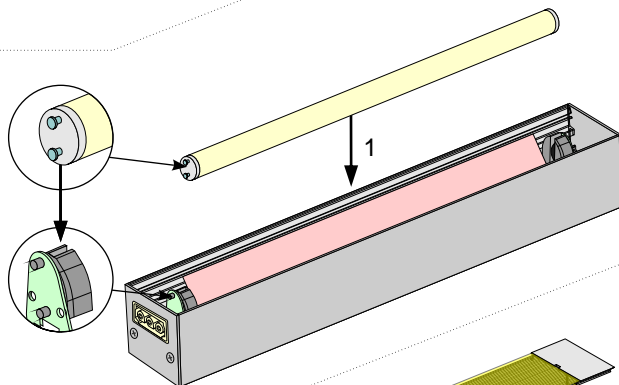

3b

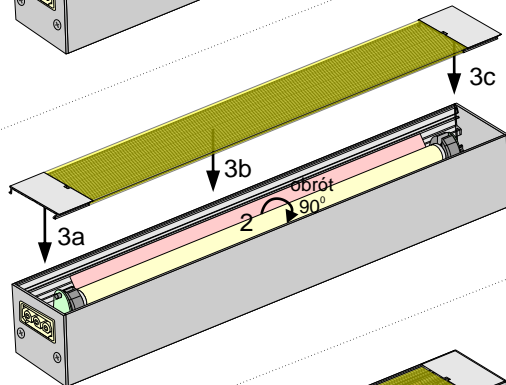

3c

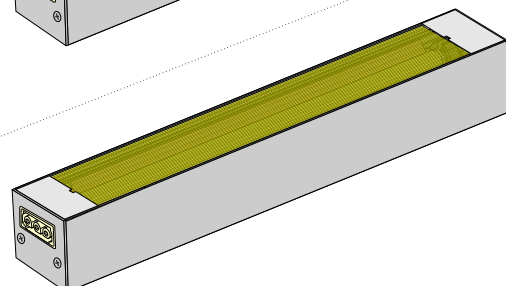

5 POŁ CZENIE ELEKTRYCZNE

Phil53 SO - System obrotowy

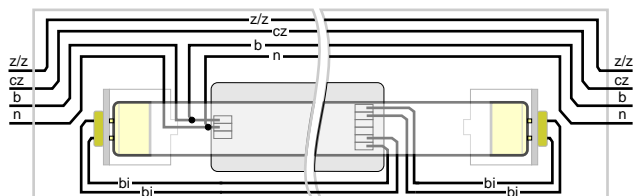

Phil53 SK - System konektorowy

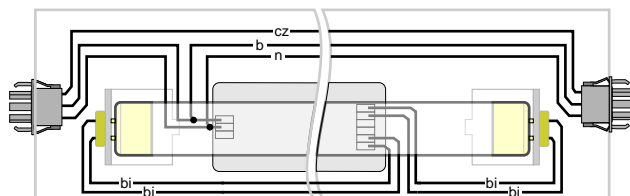

Phil53 BN

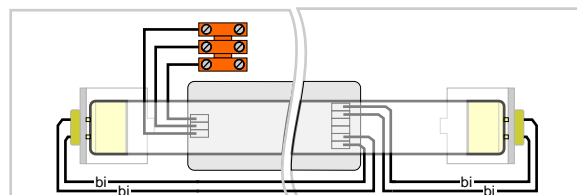

kolorystyka przewodów:

b - br z
bi - biały
bb - bezbarwny

cz - czarny
n - niebieski
z/z - żółto-zielony

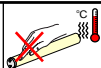
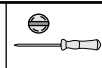
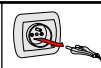

230V ~

